

The  
**Morgan 4/4**  
SERIES II



---

---

**INSTRUCTION  
BOOK**

---

---

MORGAN MOTOR CO. LTD.  
MALVERN LINK  
WORCS.

TELEGRAMS:  
MORGAN MOTORS, MALVERN

TELEPHONE:  
MALVERN 106

**7/6**

The  
**MORGAN 4/4**  
SERIES II



---

---

*Instruction Book*

---

---

THE MORGAN MOTOR CO. LTD.  
MALVERN LINK    ::    ::    ::    WORCS.

## CONTENTS

	<i>Page</i>
Battery . . . . .	18
Brakes . . . . .	17-40
Clutch . . . . .	36
Decarbonising . . . . .	27
Differential . . . . .	37
Gearbox . . . . .	16-37
Gear Changing . . . . .	7
Hood . . . . .	43
Jacking System . . . . .	42
Lubricating Chart . . . . .	24-25
"    Engine . . . . .	13
"    Recommendations . . . . .	11
"    Location of grease nipples . . . . .	12
Oil Pressure . . . . .	9
Petrol Pump . . . . .	26
Rear Axle . . . . .	16-37
Service Agents . . . . .	44-46
Shock Absorbers (Front) . . . . .	18
"    "    (Rear) . . . . .	18
Side Curtains . . . . .	43
Sparking Plugs . . . . .	21
Springs (Rear) . . . . .	17
Steering and front suspension . . . . .	12-38
Tappets . . . . .	32
Timing, Ignition . . . . .	21
Transmission Shaft . . . . .	37
Tyre Pressures . . . . .	42
Wheels—Adjustment and Balance . . . . .	42

## FOREWORD

The Morgan 4/4 Series II has been designed to provide a car with a good performance, comfortable and easy to handle and handsome in appearance, at the same time simple to maintain and economical to run.

Each car is carefully built and tested, but the continued satisfaction of the owner is largely in his own hands. The best of cars will not run well unless careful attention is paid to their upkeep.

For this reason we are issuing this Instruction Book, hoping that it will be of interest and use to owners.

There are three points we wish Morgan Users to bear in mind.

1. The importance of regular lubrication, which in the Morgan is a very simple matter.

2. The necessity of keeping nuts, bolts and screws tight. The pleasure of driving a car is often spoilt by noises and rattles, which can easily be avoided if loose parts are attended to at once.

3. The importance of seeing that the brakes are adjusted properly and in good working order.

We do not advise alterations or adjustments unless absolutely necessary, and then it will be better to get our advice which will be given if it is asked for.

## LICENCE DATA

Chassis Number ... On O/S top of cross member under front seat  
 Engine Number ... N/S of the cylinder block, near the oil filler tube

## GENERAL SPECIFICATION

### ENGINE

Number of cylinders ... Four  
 Bore of cylinder ... 2.5" (63.5 mm.)  
 Stroke ... 3.64" (92.5 mm.)  
 Cubic Capacity ... 71.55 cu. ins. (1,172 c.c.)  
 Compression Ratio ... 7.0—1 mean  
 Firing Order ... 1, 2, 4, 3  
 B.H.P. ... 36 at 4,500 r.p.m.  
 Valve clearance (cold) 0.0115" to 0.0135" (0.29 mm. to 0.34 mm.)

### OIL CAPACITY

Engine ... Inc. Filter, 5½ Imp. (6.3 U.S.) pints, 3 litres  
 Excl. Filter 4½ Imp. (5.4 U.S.) pints, 2.56 litres  
 Gearbox ... 1¾ pts. (1 litre)  
 Rear Axle ... 2 pts. (1.1 litre)

### WATER CAPACITY

Cooling system ... 14 pts. (8 litres)

### PETROL

Tank Capacity ... 8½ galls. (39 litres)

### GENERAL DIMENSIONS

Wheelbase ... 8 ft. (244 cm.)  
 Track (Front and Rear) 3' 11" (119 cm.)  
 Ground Clearance ... 7" (19 cm.)  
 Turning Circle ... 32' (10 metres)  
 Tyre Size ... 5.00" X 16"

### Overall Dimensions 2-Seater

Length ... 12' (366 cm.)  
 Width ... 4' 8" (142 cm.)  
 Height (Hood erected) 4' 3" (129 cm.)

It is recommended that Bluecol Anti-Freeze be used in the winter months. The correct mixture is 20% Bluecol, 80% water, which gives protection against frost damage down to 35° of frost.

## BODY DIMENSIONS

**2-Seater**

Seat to Hood ... 3' 1" (94 cm.)  
 Width at Elbows ... 3' 6½" (108 cm.)  
 Height of seat from floor ... 8" (20 cm.)  
 Leg room ... 23"—25" (58 cm.—63 cm.)  
 Door width at waistline ... 2' 3" (68 cm.)  
 Luggage Space. Length ... 3' 2" (96 cm.)  
 Width ... 1' 4" min. (40 cm.)  
 Depth ... 12" (30 cm.)

### Weights

	Complete with tools and full of petrol	Shipping Weight
	cwts. qrs.	cwts. qrs.
2-Seater	13 0 (660 kg.)	12 2 (630 k.g.)
	1,456 lbs.	1,390 lbs.

### IGNITION SYSTEM

Initial Ignition Setting ... 5° B.T.D.C.  
 Distribution Points Gap ... .014" to .016" (.36 to .41 mm.)  
 Spark Plug—Type ... Champion L10, 14 mm.  
 Gap ... .025" (.64 mm.)

### CARBURETTOR JET SIZES

Idling Jet ... 50  
 Main Jet ... 110. Power 115  
 Starter Jet ... 130  
 Idling Air Bleed ... 1.2 mm.  
 Starter Air Jets ... 5.0 mm.  
 Main Air Correction Jet ... 160  
 Choke Tube Diameter ... 21 mm.

### FRONT WHEEL ALIGNMENT AND SUSPENSION

Castor ... 4°  
 Camber ... 2°  
 King pin inclination ... 2°  
 Toe-in ... ⅛" to ⅜" (3.2 mm. to 4.8 mm.)

### TRANSMISSION

Clutch : Single dry plate hydraulically operated.  
 Gearbox : Three-speed, constant mesh, syncromesh on top and second gears.  
 Rear Axle : Three-quarter floating, hypoid crown wheel and pinion.  
 Clutch Release Arm Movement : ⅓" (2.54 mm.).

**TRANSMISSION—continued.**

Gear Ratios	Gearbox		Overall
	1st :	3.894	17.29
2nd :	2.007	8.91	
Top :	1.00	4.44	
Reverse :	4.451	19.76	
Rear Axle Ratio	4.44—1 with overdrive 3.3—1		

**PERFORMANCE DATA**

	Engine Speed at		With Overdrive	
	10 m.p.h.	10 km.p.h.	10 m.p.h.	10 km.p.h.
Top	585	363	435	270
2nd	1,174	729	872	542
1st	2,278	1,415	1,692	1,050
Rev.	2,600	1,616	1,937	1,203

**CONTROLS, SWITCHES AND INSTRUMENTS**

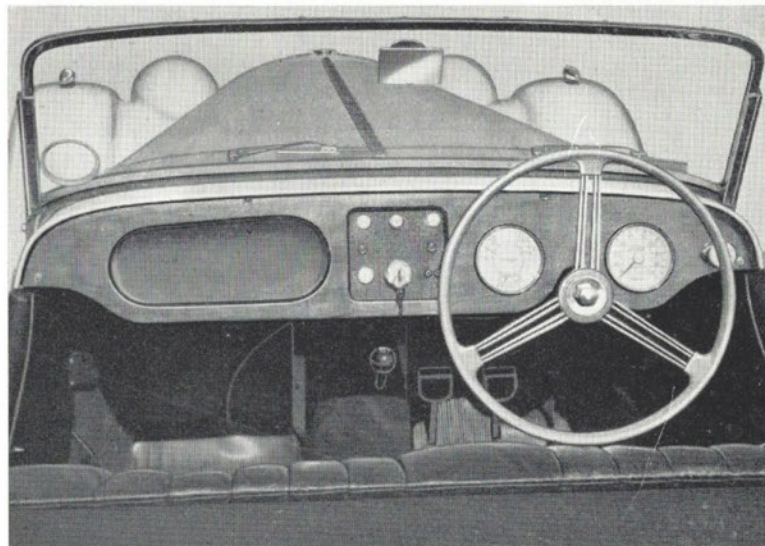

Fig. 1

**CHOKE CONTROL**

Pull out the control to the stop when starting, when engine is sufficiently warm push choke back to half-way. After one or two minutes driving as the engine reaches normal temperature it will be possible to push the control right in without causing the engine to run with undue hesitation.

**GEAR LEVER**

Always select neutral position before starting the engine.



**HAND BRAKE**

Ratchet type situated alongside steering column. Pull back, squeeze and release forward to free.

## ACCELERATOR

The pedal is connected by a Bowden cable to the carburettor throttle. Do not depress pedal when starting engine from cold.

## FOOT BRAKE

Operating four wheel hydraulic brakes.

## CLUTCH (Hydraulic Operation)

Press pedal to disengage drive from engine to gearbox. *Do not rest your foot on the pedal when driving, or hold the clutch out to free wheel, as this will CAUSE UNNECESSARY WEAR TO THE CARBON THRUST PAD.*

## BRAKE LIGHT SWITCH

The switch is connected to the brake pedal mechanism but will operate the red rear lights only with the ignition switched on.

## HEAD, TAIL AND SIDE LAMPS

Turn switch clockwise to first notch, which operates side and tail lamps, turn switch in same direction to second notch in order to operate headlamps. Press foot dip switch to operate headlamp dip. Press again for full on position. The switch for fog lamp (marked " F ") is situated in the centre of facia board.

## HEADLAMP DIPPER SWITCH

Foot-operated, situated above the clutch pedal on scuttle.

## HORN

Press to operate.

## IGNITION

Turn clockwise to switch on. Do not leave the switch " on " when engine is stationary, to avoid the battery being discharged by current flowing through the coil windings.

## STARTER BUTTON

Push to operate engine starter. *Do not re-operate until starter motor and engine have come to rest.*

## WINDSCREEN WIPER

Pull to operate wipers, they will only function when the ignition is switched on. Push to stop when arms are in the desired parking position.

## FOOT LUBRICATION CONTROL

Press to operate (see Lubrication, pages 12-18, for full instructions).

## DIRECTION INDICATORS (when fitted)

A warning light on the switch shows when the indicators are operating.

## OIL PRESSURE GAUGE

Indicates pressure of oil being pumped to the bearings. It does not show the amount of oil in the sump (excepting that if the oil level is dangerously low the pressure usually falls, due to overheating.) The oil pressure gauge should read 20-40 lbs./sq. in. when the car is travelling at approximately 30 m.p.h. and the oil is hot. A low oil pressure is quite normal if the engine is idling or running at low speeds.

## IGNITION WARNING LIGHT

Glow red when ignition is switched on with the engine idling or stopped. Should the light appear when the engine is running at normal speeds, this indicates a fault on the battery charging system.

## HEADLAMP WARNING LIGHT

Glow red when the headlights are full on.

## AMMETER

Indicates the rate of charge or discharge of the battery. The rate of charge falls off progressively as the battery approaches fully charged condition.

## FUEL GAUGE

Operates only when ignition is switched on.

## SPEEDOMETER

Is fitted with a trip which is cancelled by pushing up the serrated knob (situated under the dash board) and turning anti-clockwise.

## PANEL LIGHT

Pull knob to switch on panel lights. These lights will only operate when parking lights are switched on.

## INSPECTION LIGHT SOCKET : 12-VOLT

This socket may be used as an inspection light terminal or alternatively gives a useful means of fitting charging plant leads.

**NEW ENGINES**

When the car is new, the engine may seem to be somewhat lacking in power due to the working surfaces not having become fully bedded down. This will continue for the first 500 miles (800 km.) during which time the engine will become gradually "run-in" (with proper use). The power will then improve as the car is used for the first 2,000 miles (3,200 km.), and this will be accompanied by a corresponding improvement in petrol consumption. The engine sump should be drained and refilled with new oil at the completion of the first 1,000 miles.

It is inadvisable to run a new car fast or to run the engine at high speeds in low gears. The good and lasting bearing surfaces obtainable by careful running-in are well worth the patience required to drive at only moderate speeds for at least the first 500 miles (800 km.).

It is not recommended that the engine should be religiously driven at the specified speeds for the first 500 miles, but suggested that "running-in" should be progressive and that no harm is done if the engine is allowed to "rev" fairly fast (not raced) so long as it is thoroughly warm, but do not allow it to *pull hard and labour* on hills in any gear.

During the running in period the use of an upper cylinder lubricant is beneficial. This should be added to the petrol in quantities as recommended by the makers of the preparation used.

Running in compounds containing Acheson's colloidal graphite are available. These should only be used during the running in period for new or reconditioned engines.

During the first 500 miles (800 Km.), it is inadvisable to exceed the following speeds in gears :—

First gear	10 m.p.h., 16 k.p.h.
Second gear	25 m.p.h., 40 k.p.h.
Top gear	40 m.p.h., 65 k.p.h.

This table is not intended as a hard and fast ruling on the matter, but should be regarded as a guide.

Some variations to carburettor and ignition settings can now be made with advantage, since these were, of necessity, adjusted when the engine was new. Your agent will be glad to attend to this when he carries out the 1,000 mile service.

**MORGAN RECOMMENDED LUBRICANTS**

	SHELL	ESSO	PRICE'S	WAKEFIELD	MOBIL OIL
Engine— U.K.					
Summer	X-100 Motor Oil 30	Essolube 30	Energol S.A.E. 30	Castrol XL	Mobiloil A
Winter	X-100 Motor Oil 20/20W	Essolube 20	Energol S.A.E. 20	Castrolite	Mobiloil Arctic
Overseas Temps. above 70°F.	X-100 Motor Oil 40	Essolube 40	Energol Motor Oil S.A.E. 40	Castrol XXL	Mobiloil AF
Temps. 40°—70°F.	X-100 Motor Oil 30	Essolube 30	Energol Motor Oil S.A.E. 30	Castrol XL	Mobiloil A
Temps. below 40°F.	X-100 Motor Oil 20/20W	Essolube 20	Energol Motor Oil S.A.E. 20W	Castrolite	Mobiloil Arctic
<b>Gearbox</b>	<b>Spirax 80 EP</b>	<b>Esso Espee Compound 80</b>	<b>EP-S.A.E. 90</b>	<b>Castrol Hypoy 80</b>	<b>Mobilube GX.80</b>
<b>Rear Axle</b>	Spirax 90 EP	Esso Expee Compound 90	Energol Transmission Oil EP—S.A.E. 90	Castrol Hypoy	Mobilube GX.90
<b>Steering Box</b>	Spirax 140 EP	Esso Expee Compound 140	Energol Transmission Oil EP—S.A.E. 140	Castrol Hi-Press	Mobilube GX.140
<b>Wheel Bearings</b>	Retinax A or RB	Esso Grease	Energol C.3	Castrollease Heavy	Mobil Hub Grease
<b>Dynamo</b>	Retinax A or RB	Esso High Temperature Grease	Energol N.2	Castrollease Heavy	Mobilgrease M.P.
<b>Chassis Grease Points</b>	Retinax A or C	Esso Pressure Gun Grease	Energol C.3	Castrollease CL	Mobilgrease M.P.
<b>Oil Can</b>	X-100 Motor Oil 20/20W	Essolube 20	Energol Motor Oil S.A.E. 20W	Castrolite	Mobiloil Arctic

## LUBRICATION

**CHASSIS.** This is one of the most important subjects in connection with the upkeep of the car, and careful attention to the following remarks and instructions will be amply repaid by the results obtained, and the utmost satisfaction from the Morgan 4/4 will result from the use of the Lubricants specified.

A chassis lubrication chart is included in the centre pages of this Instruction Book, and the recommended mileages at which lubrication should be carried out are indicated.

Grease nipples are located as follows (see Chassis diagram) :—

- 1 to each front sliding axle.
- 2 on pedals.
- 1 to each universal joint on the Propeller Shaft.
- 1 to each Rear Hub.
- 2 on track rod ends.
- 1 on hand brake cable.

In addition to the nipples mentioned, apply oil periodically to the ball joints of the steering drag link, rear brake yoke pins, and balance lever pivots, gear change mechanism, the engine control lever joints, etc. It is also beneficial to apply a spot of oil occasionally to the threads of the wheelstuds in order to prevent the nuts becoming rusted on.

### FRONT SUSPENSION

Lubrication of the sliding axles is carried out by the "one shot" lubrication system. The plunger for operating this lubrication is situated in the centre of the metal scuttle and is foot operated. Although it is difficult to give a definite mileage between use it is recommended that the plunger be pressed at least every 200 miles (320 Km.). The plunger should be pressed down by foot for a few seconds during which time a very small decrease in oil pressure may be observed on the oil gauge.

As mentioned before, the sliding axles are also provided with grease nipples which should be lubricated with grease every 3,000 miles, the grease helping to retain oil supplied by the "one shot" system.

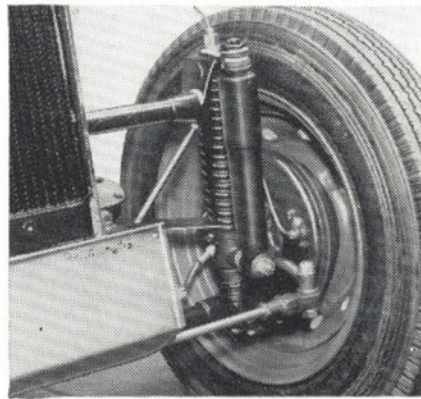

Fig. 2

A small amount of lubricating oil on the steering friction dampers is beneficial should the steering become stiff.

**The importance of frequent lubrication to the sliding axles cannot be too highly stressed as comfort is to a large extent dependent on the free working of these parts, and neglect will result in tightness which not only makes the springing harsh, but results in excessive wear, necessitating renewal before it should be necessary.**

### ENGINE

We recommend low viscosity oils for use in the engine sump. These oils, whilst maintaining sufficient body when hot, are fluid enough to give early lubrication to cylinder walls, etc., when starting the engine from "cold", a quality not possessed by the "heavier" oils in sufficient degree for use in modern engines. They are each of the correct viscosity and character to afford complete lubrication protection. Additives which dilute the oil or otherwise impair this protection must NOT be used. We therefore stress the value of using only the recommended oils. After many thousands of miles running the rate of oil consumption will increase. When the rate becomes higher than one gallon per 1,000 miles (1 litre per 400 Km.), it will be desirable to use the next heavier grade of the brand of oil you normally employ.

The engine oil should be drained after the first 300 miles and thereafter every 5,000 miles. The oil filter element should also be changed at this latter mileage. A good quality flushing oil may be used in the engine, but in no circumstances may paraffin be used to flush the crankcase. It is advisable to check the engine oil level every morning or every 250 miles, with the car standing on level ground.

To check the oil level pull out the dipstick, wipe off all traces of oil with a clean rag, fully re-insert into the engine sump and again withdraw the dipstick. The mark made by the oil on the lower end of the dipstick will indicate the oil level.

Further oil need only be added when the level falls below the line marked "Full." In no circumstances should the oil level be permitted to fall below the "Fill" line into the sector marked "Danger" since this will mean that the engine is running with insufficient oil and serious damage may be caused.

When replacing the dipstick, push it down until the handle contacts the top of the tube, otherwise oil may be lost from the dipstick tube.

The amount of oil required to make up between Fill and Full on the Dipstick is 2 pints.

### CHANGING THE OIL FILTER ELEMENT

The oil filter is located on the left-hand side of the cylinder front cover and the filter element should be changed every 5,000 miles.



Unscrew the centre bolt and lower the filter body and element. The filter body will contain a quantity of oil which should be drained off and the used element discarded.

Clean the filter body and fit a new element on the centre bolt with the flat end towards the filter body, i.e. downwards. Fit a new rubber sealing ring in the groove of the engine side cover casting, ensuring that it seats evenly.

Replace the filter body and tighten the centre bolt. Take care not to overtighten the centre bolt, otherwise the rubber sealing ring may be distorted.



Fig. 3

#### CLEANING THE BREATHER CAP

Wash the filler and breather cap in petrol and then dip in clean engine oil. Shake out the surplus oil before refitting it to the engine.

#### IGNITION DISTRIBUTION (See Fig. 4)

Every 5,000 miles (8,000 Km.) the cam should be smeared lightly with engine oil. A pronounced squeak occurs when the cam is

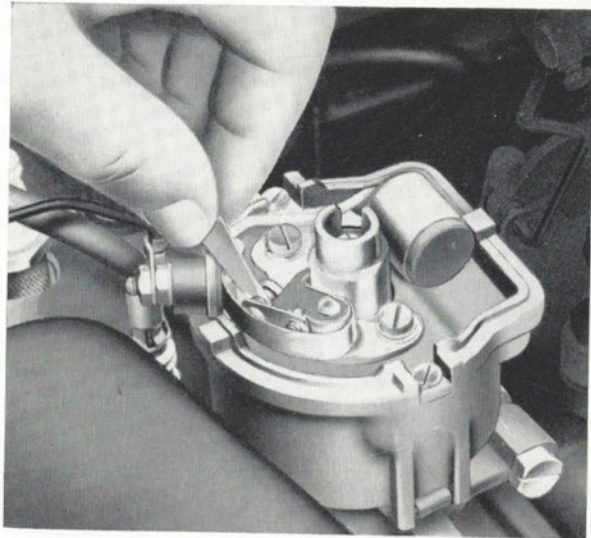

Fig. 4

quite dry. Withdraw the moulded rotor arm from the top of the spindle (care should be taken because this part is made of a brittle material), but do not remove the screw exposed to view. Apply, by means of oil-can, a few drops of thin machine oil around the edge of the screw and down the hole provided, to lubricate the cam bearings and distributor spindle respectively. At the same time, place a single drop of clean engine oil on the contact breaker arm pivot.

When replacing the rotor arm make sure that it is pushed on as far as possible.

The moving parts of the automatic advance mechanism should be lubricated with winter grade engine oil. This can be squirted through the gap between the cam and the base plate. Take great care not to allow any oil to get on or near the contacts.

#### DYNAMO

Once every 10,000 miles a few drops of oil should be applied through the hole in the centre of the commutator end plate boss at the rear of the generator.

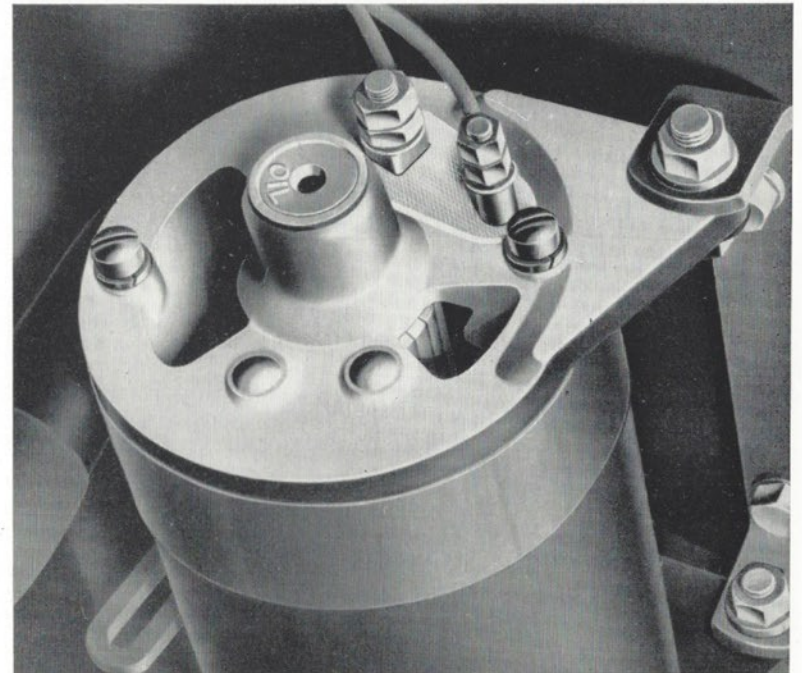

Fig. 5

## GEARBOX

The correct oil only should be used in the gearbox as the use of very thick oil or grease will spoil the operation of gear changing.

Every 2,500 miles (4,000 Km.) the oil level should be checked and topped up if necessary.

To check the oil level in the gear box, remove the level plug on the right-hand side of the box. Top-up as necessary to bring the oil to the bottom of the level plug hole.

When adding oil to the gear box, either pump it through the level plug hole or remove the gear lever by detaching the gear lever cover at the base of the gear level and unscrewing the metal cap. Ensure that the gear lever is in neutral and withdraw the gear lever from the selector housing.

When replacing the gear lever, ensure that it seats in its socket and the two trunnions locate in the slots of the selector housing top. Screw the cap down tight (do not forget the cork gasket beneath the cap) and replace the gear lever cover.

The gearbox should be drained and refilled every 10,000 miles.

## REAR AXLE

It is essential to drain and replenish the axle with "Hypoid" oil every 5,000 miles (8,000 km.). To drain, remove rear cover.

**The hypoid bevel gears fitted in the rear axle require a special lubricant to ensure efficient operation and long life.**

This type of gear incorporates a sliding action between the exceptionally sturdy gear teeth, resulting in silent operation. However the rubbing action is too severe for normal oils, so special "Hypoid" oils have been developed which contain additives that make the oil capable of withstanding pressures many times heavier than normal oils can cope with. A further feature of "Hypoid" oils is that they are "lighter"—that is to say, more fluid than normal axle oils. However, the special additives begin to lose their properties in the course of use, and the oil tends to revert to a light gear oil.

Thus it is advisable to completely drain and replenish with new "Hypoid" oil every 5,000 miles (8,000 Km.), and in any event do not exceed a period of 10,000 miles (16,000) Km..

It is desirable to have the oil level checked during this period and if the oil level is below the plug on the rear do not "top up" but drain the oil and refill with new oil, this will overcome the danger of mixing the various grades of oil.

The filler and level plug is combined on the rear of the differential case, clean away grit before unscrewing the plug.

## BRAKE AND CLUTCH FLUID RESERVOIRS

It is important that the filler cap on the brake and clutch fluid reservoirs should be removed every 5,000 miles (8,000 k.), the fluid level checked and topped up if necessary. The level in the reservoir should be about half-an-inch from the top; do not fill completely.

The reservoirs are situated on master cylinders and are located under the right-hand side of the bonnet on right-hand drive models, and on left-hand drive in a corresponding position on the left-hand side.

As the cups in the master and all wheel and clutch cylinders are pure rubber it is imperative to use only Girling hydraulic fluid. Ensure that the air vents in the filler caps are not choked. Blockage at this point would cause the brakes and clutch to drag.

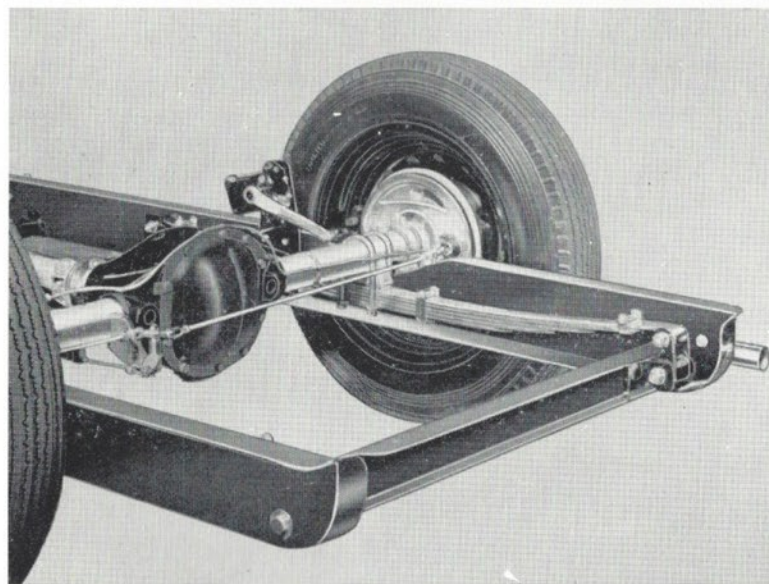

Fig. 6

## REAR ROAD SPRINGS

The spring blades should not be allowed to get rusty as this will prevent the correct working of the springs and provide a hard suspension.

Service stations are often equipped to spray the springs with penetrating oil, but this is not lasting in effect, and it is advisable afterwards to paint over with rear axle or engine oil.

It is the area around the tips of the blades which most requires the lubricant, as it is at these points that one blade presses upon the next. The spring clips should also be oiled.

Rubber bushes are fitted in the front and rear of the rear spring eyes and must not be lubricated.

### STEERING

Check oil level in box every 5,000 miles (8,000 Km.).

Grease should never be used in the steering box, or seizure of the rockershaft will occur. The recommended oil is a medium to heavy gear oil such as Hypoid 90 or S.A.E. 140.

The felt bush at the top of the steering column may in time become dry and cause a squeak when the steering is operated. It is recommended that the application of a little graphited oil, such as upper cylinder lubricant, be used to cure this. Do not saturate the felt with oil or it will soon become useless.

### HYDRAULIC DAMPERS

The piston and telescopic type dampers fitted should not require any attention such as "topping up". If they become inoperative they should be serviced by the makers.

### HINGES, CONTROLS, DOOR LOCKS, ETC.

The bonnet catches, hinge and several small control joints should be given occasional attention with the oil can. Door locks should receive a drop of oil every month to ensure easy operation.

The accelerator cable and choke control, etc., all require occasional attention to allow controls to work freely and prevent unnecessary wear.

### THE BATTERY

At frequent intervals (especially in hot climates) top up each cell with distilled water to bring the acid solution (electrolyte) level with the top of the separators. Do not use a naked light when examining the conditions of the cells and on no account use tap water when topping up. Keep the terminals clean and well covered with petroleum jelly. If they are corroded, scrape then clean, assemble and cover with petroleum jelly. Wipe away all dirt and moisture from the top of the battery, and make sure that the connections are clean.

## ENGINE

### FRONT END VIEW

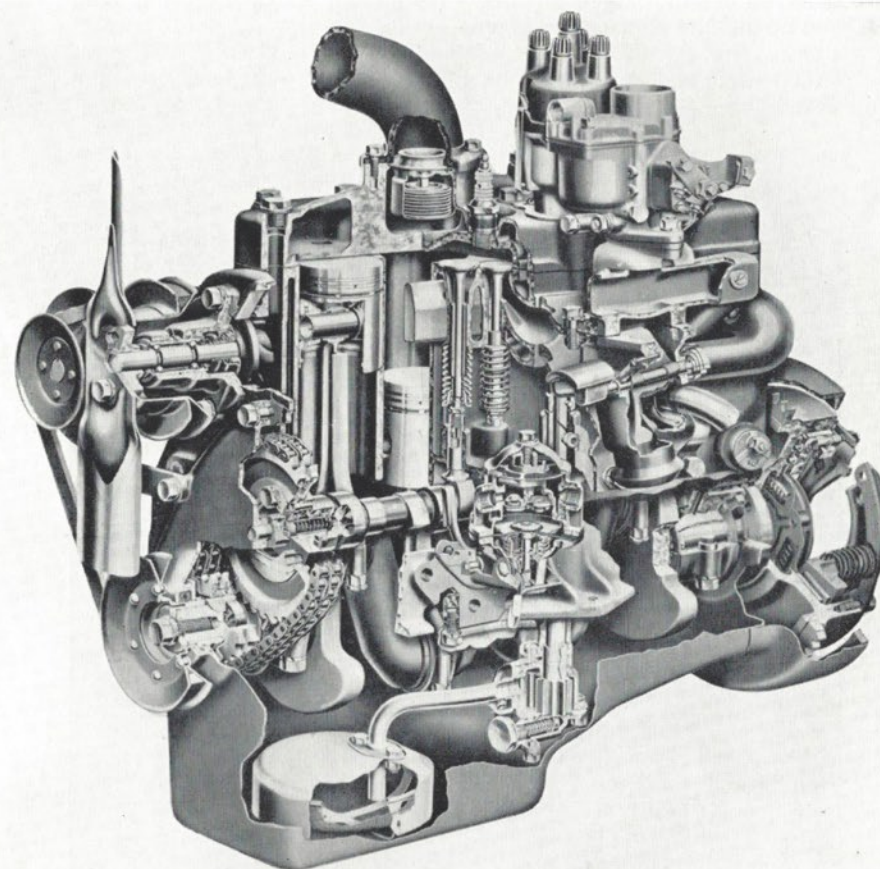

SECTION THROUGH ENGINE

## ENGINE

### ENGINE MAINTENANCE AND ADJUSTMENTS

Various adjustments are necessary from time to time in order to keep the mechanism in efficient running order. The periods between depend largely upon the manner in which the car is used and no definite time can be given here for carrying out these corrections. The car should be examined, however, every 5,000 miles (8,000 Km.) and any adjustments which appear necessary can then be made.

### CYLINDER HEAD NUTS

After the first 300 miles (500 km.) the cylinder head nuts should be checked, with engine warm, for tightness in the order shown.

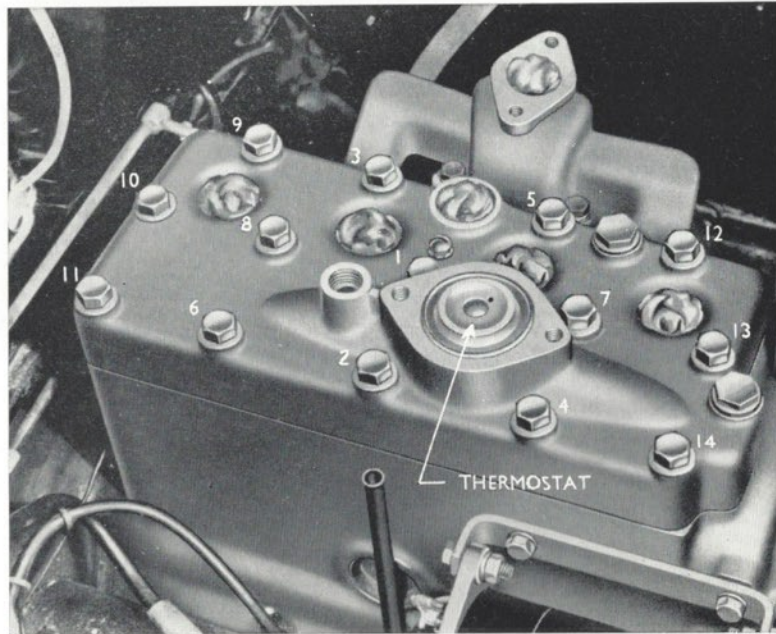

Fig. 7

### IGNITION TIMING

The ignition is automatically advanced to suit the ever changing needs of the engine. When fully retarded, i.e., engine at rest, the ignition should be set to fire 5° before top dead centre (measured at the crankshaft).

The ignition is correctly set at the works and should not normally be adjusted, excepting that after the car has covered a considerable mileage it may be necessary, due to the increased carbon deposit, to set back slightly the ignition, to prevent a metallic sounding noise termed "pinking". It is evident when pulling hard up-hill or when accelerating from low speed in top gear.

The setting recommended below should be regarded as a starting point, as individual engines may require more or less advance than this. Maximum power is obtained by giving the greatest possible advance without causing pinking. Minor adjustments can readily be made on the road.

To adjust ignition, slacken the body bolt and turn the distributor body clockwise, and vice versa. Do not alter the ignition more than 1° at a time (2° on crankshaft). One division on the index scale corresponds to 4° on the crankshaft.

To obtain TOP DEAD CENTRE position, remove the sparking plugs and turn the engine slowly in a clockwise direction by means of the fan belt, until compression build up is felt in No. 1 cylinder. Continue turning the engine until the notch on the crankshaft pulley lines up with the timing mark on the cylinder front cover.

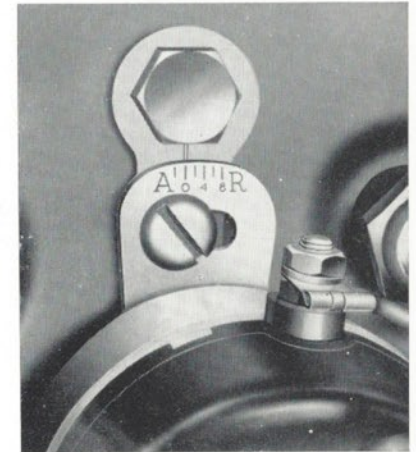

Fig. 8.

### SPARKING PLUGS

The sparking plugs were adopted for original equipment after lengthy tests as sparking plug types vary in suitability for different engines, it is important that the correct type of plug be fitted when making replacements, this is :

CHAMPION No. L10— $\frac{1}{2}$ " reach.

The gaps (i.e., the width between the firing point of the centre electrode and the earth point) are originally set and should be maintained at twenty-five thousandths of an inch (0.64 mm.) to ensure even running of the engine.

Incorrect gap settings may cause misfiring or erratic slow running. Faulty plug leads or cracked porcelain insulation in the sparking plug will also cause faulty ignition.

Sparking plugs should be thoroughly cleaned, checked and adjusted, if necessary, for gap setting after 5,000 miles (8,000 Km.) use and at 10,000 miles or 15,000 km. should be replaced by new plugs.



Fig. 9



Fig. 10

## CARBURETTOR

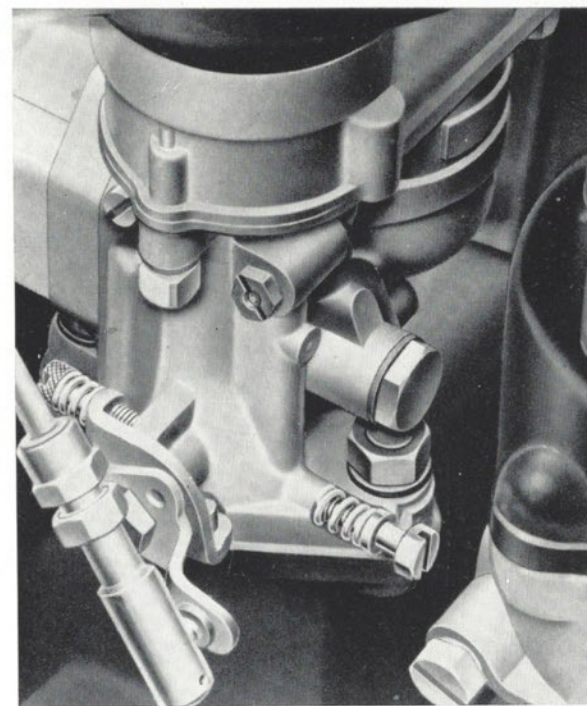

Fig. 11

The carburettor is of the downdraught type and incorporates a special two-stage starting device on the left-hand side of the carburettor body.

All adjustments are made at the time of manufacture and, with the exception of the idling adjustment, will remain permanently correct unless disturbed. The idling adjustment should be checked after the car has been "run-in."

All petrol jets are accessible from the outside of the carburettor and they should be removed and cleaned periodically. Obstructions should be cleared by blowing through the jets and passages with a tyre pump.

# LUBRICATION CHART

AT MILEAGES SHOWN

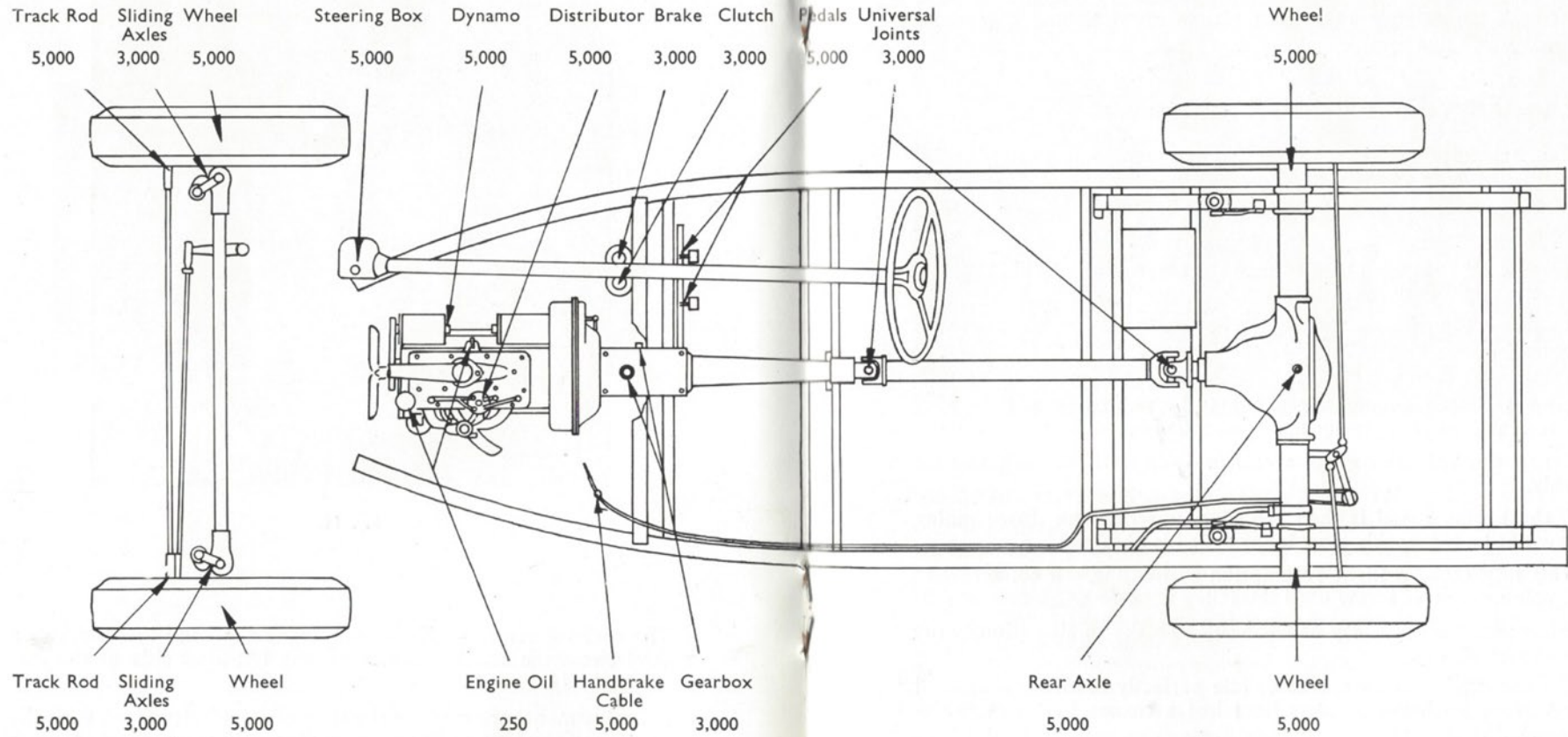

On no account use wire or anything which could enlarge the jet orifices, as the jets are calibrated to very fine limits and not only economy but also general engine performance can be upset by enlarging the jets in this manner.

The two-stage starting device on the side of the main body must be used with care, as it is designed to provide a very rich mixture for cold starting, when the choke control is pulled right out. Great care must therefore be taken to follow the starting instructions, otherwise excess petrol will pass into the engine and may cause premature engine wear.

### CARBURETTOR IDLING ADJUSTMENT

The only adjustments required are to the volume control screw and slow-running adjustment screw.

Idling adjustment must be carried out when the **engine is hot**, as follows :—

Screw in the slow-running adjustment screw until the idling speed is a little faster than normal.

Unscrew the volume control screw until the engine begins to "hunt."

Note that the volume control screw alters the volume of mixture passing into the engine. Screwing it in reduces the volume of mixture and screwing it out increases the volume.

Screw the volume control screw in again until the engine runs evenly.

If the engine speed is then too high, unscrew the slow-running screw until a reasonably slow idling speed is obtained.

This may cause a slight resumption of hunting. If so, screw in the volume control screw until the idling is perfect.

After adjustment, it may be necessary to make an alteration to the distributor timing.

Do not expect a new engine to idle perfectly at low speeds until the various machined surfaces have had a chance to "run themselves in."

### FUEL PUMP

The fuel pump is located on the left-hand side of the engine behind the oil filter. The pump is entirely automatic in action and requires little attention other than cleaning the filter screen regularly and

removal of sediment in the pump chamber. Occasionally, the fuel line unions should be checked for tightness.

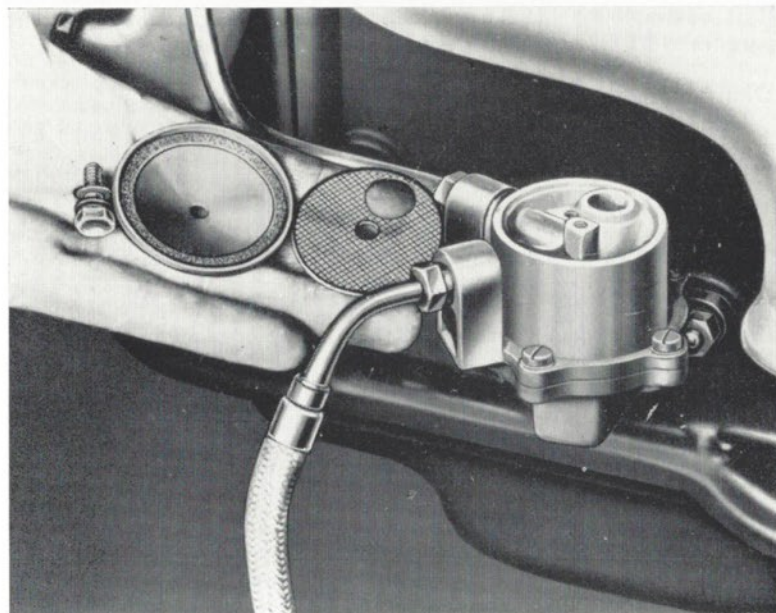

Fig. 12

### DECARBONISING AND VALVE GRINDING

It is necessary to decarbonise the engine when an excessive amount of carbon has been deposited in the combustion chambers and on top of the pistons, or there are indications of gas leakage past the valves, causing a falling off of engine performance.

One cannot stipulate any particular mileage at which the engine should be decarbonised, since the use of different fuels, lubricating oils and varying conditions can have a considerable influence on the rate of carbon formation.

For those who wish to carry out the work themselves, we have set out in the following pages the necessary points for their guidance.

#### Preparation

Before removing the cylinder head, obtain the various replacement gaskets, i.e., cylinder head, manifold to cylinder block, carburettor to manifold, fuel pump and valve chamber cover gaskets, suitable cleaning materials and one or two tools which are not included in the tool kit.

These tools are a valve spring compressor, a blunt scraper for removing carbon from the cylinder head and pistons, a valve grinding tool of the rubber suction cup type and a set of accurate feeler blades. It is advisable to have a wire brush, cleaning rag and sufficient paraffin at hand for washing the various components.

### **Dismantling**

Drain the cooling system and disconnect the choke wire at the carburettor and the throttle control at the throttle lever.

Disconnect the H.T. leads at the sparking plugs and the coil high and low tension wires at the distributor. Note the position of the index scale in relation to the cylinder head and remove the screw securing the distributor index scale to the cylinder head. Lift out the distributor.

Unscrew the wire clamp at the upper end of the radiator hose and the two bolts securing the flanged plate at the lower end of the hose, when the hose may be detached.

Remove the dipstick and engine breather cap, blocking the holes with clean rag to prevent the entry of dirt.

Unscrew the 14 cylinder head bolts. Unscrew the sparking plugs.

The cylinder head may now be removed from the cylinder block, tapping it gently on one side if necessary.

### **Removing Carbon**

Remove the carbon from the cylinder head, using a wire brush and a suitable scraper, after which the areas which have been decarbonised should be cleaned with a paraffin-soaked rag.

Ensure that all rust, jointing compound and carbon is removed from the machined surface of the cylinder head.

It is not advisable to polish the combustion chambers or cylinder head face with emery cloth, as particles may find their way into the cylinder bores and cause serious damage.

Before removing the carbon from the crowns of the pistons, smear grease round the top edge of each bore. When the pistons are at top dead centre, a seal will thus be formed around the piston crowns, preventing dirt and carbon chips from passing down between the piston and the cylinder bore.

Turn the engine until two pistons are at the tops of their strokes, i.e., at top dead centre, placing pieces of rag in the other two cylinder bores and in the distributor drive shaft well to prevent carbon falling into them.

Remove all carbon from the piston crowns, using a blunt scraper and working from the outside of the pistons towards the centre. Clean the piston crowns thoroughly, as carbon forms less rapidly on a smooth, clean surface. Do not disturb the ring of carbon round the edge of the piston crown or polish the piston crowns with emery cloth, as this may cause particules to find their way down the bores.

After cleaning these two pistons, remove the pieces of rag carefully and rotate the engine a half-turn to bring the other two pistons to the tops of their strokes, placing rags in the cleaned bores. Clean the two remaining piston crowns thoroughly, also remove any jointing compound, etc., from the machined face of the cylinder block. Any burrs should be removed.

### **Valves and Seats**

While the cylinder head is removed for decarbonising, it is advisable to examine the condition of the valves and valve seats.

It is essential that the seal between each valve and its valve seat is perfectly gastight, without any pits or burn marks on the bevelled surfaces.

This condition is achieved by grinding the two surfaces together, using a wooden-handled valve grinding tool, fitted with a rubber suction cup.

### **Removing the Valves**

Assuming the cylinder head has already been removed, unscrew the two nuts on the exhaust pipe clamp and disconnect the exhaust pipe from the manifold. Disconnect the petrol pipe at the carburettor.

Unscrew the four nuts holding the inlet and exhaust manifolds to the cylinder block and detach the manifolds, carburettor and gasket.

Disconnect the pipes at the fuel pump.

Remove two bolts which hold the fuel pump to the cylinder block. Detach the pump and gasket.

Unscrew the bolts holding the valve chamber cover to the cylinder block and the sump screw which secures the ventilation tube bracket. Disconnect the oil pressure pipe and detach the cover, ventilation tube and cover gasket. The valve mechanism will now be exposed.

Block the two holes in the valve chamber which communicate with the crankcase, using pieces of non-fluffy rag. This will prevent the valve spring seats and cotters falling into the sump.

Using the valve spring compressor on the first valve assembly which is on its seat, compress the valve spring and extract the split taper cotters from beneath the spring seat.

Remove the spring compressor, when the valve may be drawn up out of its guide and removed from the engine. Lift the valve spring and spring seat off the valve tappet and ease the valve spring off the valve guide.

Remove the remaining valves in a similar manner, turning the crankshaft as necessary to ensure that each valve is fully closed before attempting to remove it. Take particular care to keep each valve, spring and spring seat together, and keep them in their correct order so that they may be replaced in their original locations.



Note that the inlet valve heads are larger in diameter than the exhaust valve heads. Do not centre punch the valve heads, as this may distort the valve stems.

### Cleaning the Valves

The valves, springs, spring seats and valve ports should be cleaned thoroughly and the valve faces examined; where the valve seats are severely pitted, it will be necessary to grind the valves or seats to remove any pits or burn marks.

If the valves and seats are in reasonable condition, with only slight pitting, they may be ground in.

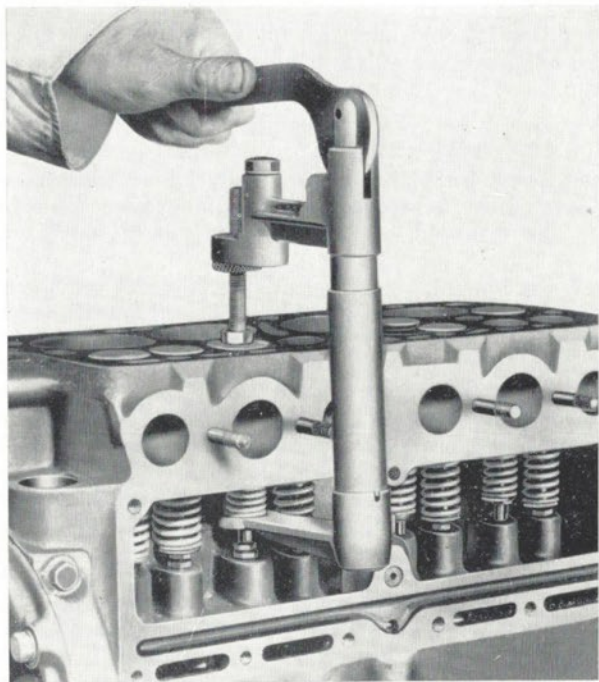

Fig. 13

### Valve Grinding

To assist those who are carrying out this work for the first time, the following points may be of assistance.

A rubber suction cup valve tool and suitable grinding paste should be obtained.

Before attempting to grind in a valve, ensure that the tappet is on the heel of the cam, i.e., in its lowest position. Turn the engine until No. 1 piston is at the top of the compression stroke, when both valves of this cylinder can be ground in.

Wipe the valve stem to remove any dirt and pass it down its valve guide. Apply a small amount of grinding paste to the valve face and then rotate the valve lightly, first in one direction and then in the other, from time to time raising the valve off its seat and turning it approximately a quarter of a turn to distribute the grinding paste, which will ensure an even concentric surface.

Only a light downward pressure on the valve is required as this, together with the weight of the valve tool, is sufficient to grind the valve on to its seat.

Valve grinding paste is normally obtainable in both fine and coarse grades. The selection of paste to be used is, of course, dependent upon the condition of the valve. If the surfaces are badly pitted, it will be quicker to commence grinding with coarse paste until the irregularities have been ground away, then finish off with a fine paste until a good matt finish has been obtained.

When correctly ground in, the valve seat and face should have an even, clean, grey matt finish. There should be no sign of bright rings around the valve face and all evidence of pitting should be removed. Bright rings are caused by grinding with insufficient paste, while "tramlines" are usually caused by rotating a valve continuously on its seat without allowing it to take up a different position during the backward and forward motion of the valve.

If a valve is distorted, or the valve head is badly burned or cracked, a new valve should be fitted and ground-in as described above.

After grinding-in the valves, clean all parts thoroughly, reassemble to the engine and adjust the valve clearances.

### Reassembling the Valves

It is essential to remove all traces of valve grinding paste from the valve ports and seats. Take care not to wash the paste away with petrol as this may carry the abrasive into other working parts of the engine.

Check for wear of the valve stems and guides. If excessive clearance exists between these parts, it is advisable to have new valves fitted and the valve guides replaced.

Clean the valve stems and guides and lubricate each stem with engine oil. Locate each valve in its appropriate guide.

Turn the engine to bring No. 1 piston to the top of its compression stroke, i.e., when the first two tappets are in their lowest positions, and locate the valve springs around the first two valve guides.

Locate the spring seat on the lower end of each valve, so that it seats in the end of the valve spring.

Using the valve spring compressor as shown in Fig. 13, compress the valve spring, raising the spring seat. Carefully locate the two split cotters in the tapered bore of the spring seat, so that they also engage in the groove in the end of the valve stem (see Fig. 14).

Release the valve spring compressor carefully, holding the cotters in place until the taper on the spring seat engages with the taper on the outside of the cotters.

Repeat this operation on the remaining valves, turning the crankshaft as necessary to bring the respective tappet on to the heel of the cam.

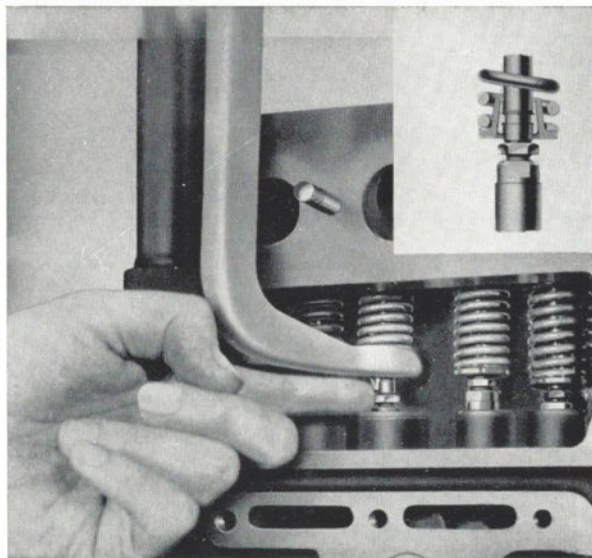

Fig. 14

### Adjusting Valve Clearances

It will be appreciated that the effect of grinding in the valves will decrease slightly the valve clearance between the end of the valve stem and the tappet. The correct clearance, when the engine is cold and with the tappet on the heel of the cam, is .0115 in. to .0135 in. for both inlet and exhaust valves.

The tappets are adjustable, having threaded adjuster studs which are self-locking.

First, check that the tappet is on the heel of the cam, i.e., in its lowest position, and insert a feeler blade between the end of the valve stem and the tappet adjuster (see Fig. 15).

If the clearance is incorrect, i.e., not within the limits .0115 in. to .0135 in., hold the tappet with a suitable spanner (supplied in the tool kit) and turn the adjuster to bring the clearance within the prescribed limits.

Repeat this adjustment on all valves, turning the crankshaft as necessary.

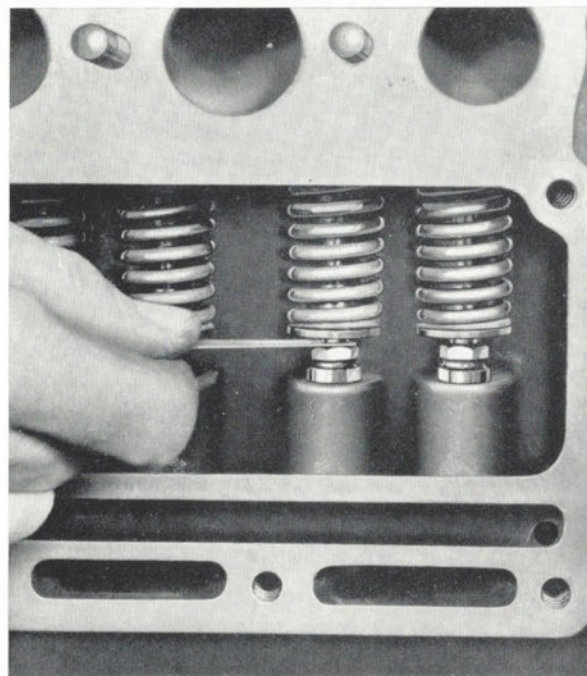

Fig. 15

### Reassembling the Engine

Remove any traces of the old gasket, jointing compound, etc., from the valve chamber cover face and any sludge from the main oil gallery at the base of the chamber. Also extract the pieces of rag used to block the ports leading into the crankcase.

Locate a new gasket on the machined face of the cylinder block and refit the valve chamber cover and ventilation tube assembly. Note that the bolt in the centre of the top edge of the cover and the bolt nearest the fuel pump are shorter than the rest. Tighten the bolts securely, also replace the sump screw which secures the bracket at the lower end of the ventilation tube. Reconnect the oil pressure pipe on the valve chamber cover.

Fit a new gasket on the fuel pump mounting face, applying jointing compound if necessary, and replace the fuel pump so that the rocker arm passes between the eccentric on the camshaft and the crankcase wall. Refit the bolts and washers and tighten securely.

Locate a new inlet manifold gasket on the studs above the valve chamber cover and refit the manifolds and carburettor, securing them with nuts and flat washers which should be tightened evenly.

Refit the exhaust pipe to the manifold flange, using the two semi-circular clamps. Tighten the clamp nuts evenly and securely, noting that brass nuts are used to prevent them rusting on the thread.

Connect the throttle control to the lever at the rear of the carburettor and the choke control wire to the trunnion on the left-hand side of the carburettor.

Reconnect the fuel pump to carburettor pipe to the unions on the pump and carburettor, ensuring that they are not cross-threaded. Also remove the plug and reconnect the fuel tank to pump pipe, tightening the union securely.

### Replacing the Cylinder Head

Before replacing the cylinder head and gasket, clean up the top of the cylinder block and cylinder bores.

Remove all traces of grease and carbon from the piston crowns and cylinder walls and pour a small quantity of clean engine oil down each bore.

Locate a new cylinder head gasket on the top face of the block, smooth side downwards, with the water ports and bolt holes in line, and replace the cylinder head. Replace the cylinder head bolts.

Ensure that the hole in the cylinder head, which receives the distributor body shank, is concentric with that in the gasket and cylinder block face.

Tighten the bolts, a little at a time, in the order shown in Fig 7. The use of the correct tightening sequence is essential to prevent water and gas leaks at the cylinder head joint.

Refit the four sparking plugs and gaskets, checking that the plugs are clean and correctly gapped at 0.25 in. Tighten the plugs securely, using a box spanner.

Refit the thermostat in the cylinder head and reconnect the radiator upper hose to the inlet on the radiator and locate it on the cylinder head water flange. Check that the metal clamp plate over the hose lower flange is in good condition, replace the two bolts and tighten securely. Tighten the wire clamp at the upper end of the hose.

Turn the engine until the notch on the crankshaft pulley is in line with the timing mark on the cylinder front cover, when No. 1 cylinder is towards the top of its compression stroke. When viewing the end of the distributor drive coupling shaft, note that the drive

tongue is offset and that the larger 'D' should be pointing towards No. 2 cylinder.

Remove the distributor cap and refit the distributor on the engine, with the index scale of the body clamp midway between Nos. 2 and 3 spark plugs and the slots on the end of the distributor shat driving collar engaging in the drive coupling tongue. The rotor should now be pointing towards No. 1 cylinder contact in the distributor cap. Refit the clamp screw and washer through the slot in the index scale, set the zero mark against the mark on the cylinder head and tighten the clamp screw.

Slacken the body clamp bolt and turn the body clockwise until the contact breaker points are just opening, at the same time turning the rotor clockwise to take up any play in the drive. Tighten the body clamp bolt. This will give the initial timing setting. Some variation from this setting may be necessary after road testing the car.

After decarbonising, it is advisable to readjust the carburettor setting as described on page 26, to compensate for the somewhat altered characteristics of the engine.

## CLUTCH, GEARBOX, TRANSMISSION SHAFT AND REAR AXLE

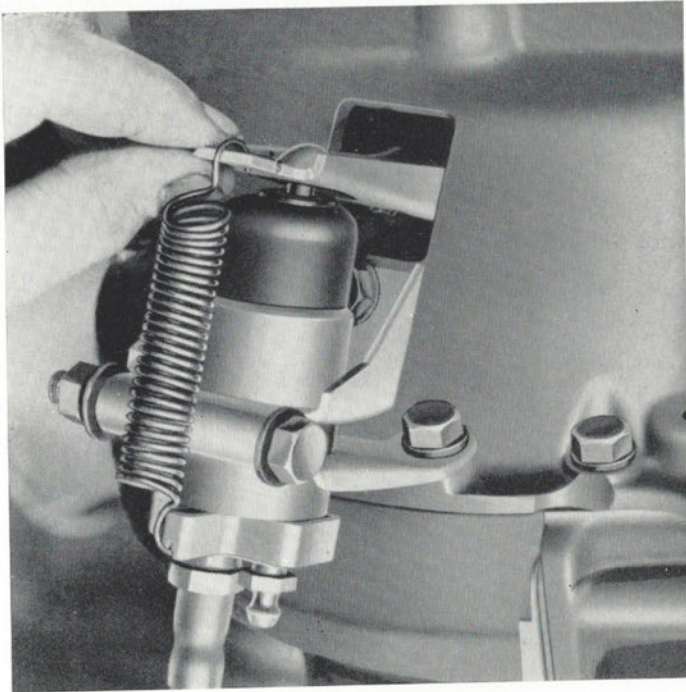

Fig. 16

The clutch is released by a hydraulic system, actuated by the clutch pedal. Fluid for the hydraulic system is fed from a reservoir on the end of the clutch master cylinder and, providing the reservoir is kept topped up to the correct level, no attention should be required other than checking the free movement of the release arm.

Should air enter the system, as could occur if the fluid level was allowed to fall to a low level, it will be necessary to bleed the hydraulic system. The bleeding of the clutch system is carried out in a similar manner to bleeding of the brakes (see page 42).

### CLUTCH ADJUSTMENT

The clearance between the clutch release arm and the operating cylinder push rod is effected by moving the operating cylinder in its bracket (see Fig. 17).

Move the end of the release arm backwards and forwards, when the total movement of the arm should be 1/10 in.

If the free movement is incorrect, slacken the clamp bolt on the operating cylinder bracket (see Fig. 17) to allow the cylinder to be moved backwards or forwards as necessary to provide the correct clearance.

Tighten the clamp bolt securely after adjustment.

### GEARBOX

This requires no adjustment or attention beyond replenishment of the oil at the periods given in the lubrication chart. A small amount of grease on the gear change rod will ensure a smooth and easy action.

### TRANSMISSION SHAFT

The Hardy Spicer Needle Bearing type universal joints require no other attention than that mentioned in Chapter III. Usually long and severe service is required before any appreciable wear is noticed. The trunnions and needle bearings are the only parts subject to wear, and when replacement is finally necessary they may be removed and replaced by hand without the need for special tools. The needle bearings are locked in position with lock rings on recessed grooves in the yokes, requiring only a pair of pliers for removal. If for any reason there is necessity to remove the bearing assembly, be sure to hold the trunnion in an upright position, so that the assembly to be removed is at the bottom. This is necessary in order to prevent the needles from falling out. In the event of their doing so, the assembly should be washed in petrol and then by smearing them with light oil or vaseline, to hold the needles in position, the bearings can readily be re-assembled. Do not use grease when re-assembling as this is liable to clog the oil passages, use a light oil. The joints have four independent oil reservoirs which carry the oil to the needle bearing assemblies.

### REAR AXLE AND DIFFERENTIAL

The rear axle fitted to the Morgan Plus Four, is of the hypoid type, of extremely sturdy construction, and should require no attention other than *correct lubrication* as indicated on page 16.

## STEERING AND FRONT SUSPENSION

### CAM GEAR STEERING—RATIO 12:1 CONSTANT

The cam itself is not actually a worm, but is generated on a special machine the cutter of which travels in the same arc as the peg in the rocker shaft. This ensures accurate peg engagement at all positions. At the centre of the cam, corresponding to the straight ahead position of the road wheels, there is a "high spot," details of which are explained below.

To test the steering gear, disconnect the drag link from the ball pin of the drop arm so that the steering wheel may be freely rotated from lock to lock. At the central position it should be possible to feel some resistance as the peg passes over the high spot referred to above. If this cannot be discerned and it is possible to spin the wheel from lock to lock without feeling the cam centre, then the thrust screw on the side cover should be turned clockwise a small amount at a time until a torque of approximately 12 lb. in. at the rim of the steering wheel is required to move over the centre. The thrust screw is secured in place by a locking nut. It should be noted that when connected up with the steering linkage on the chassis, this high spot cannot be noticed when the vehicle is driven on the road and therefore does not cause any feeling of discomfort to the driver. If it does, the adjustment is excessive and will harm the mechanism.

It should be observed that in properly adjusted condition, there will be no backlash or lost motion of the drop arm at the central position. But at any other position it will be found that the drop arm can have a certain amount of shake, which reaches a maximum at each lock. This comes about due to clearance of the peg in the cam track at all positions other than the straight ahead.

During manufacture the shims in the end cover are adjusted to allow a maximum of only 0.002" end float of the cam in the box. In time it may be necessary to remove a shim to prevent this amount being exceeded due to normal wear in service. Shims are usually provided in three sizes :—0.0024", 0.005", 0.010".

If one or more shims are removed, the end cover should then be replaced and tightened up, care being taken to ensure that the ball cages are running true and have not been allowed to become askew and forced home in this way. (Should this occur, the cages will break up and the ball bearings will drop out into the box and cause considerable damage.) It should then be possible to rotate the column by hand to guard against pre-loading if too many shims have been removed. To facilitate shim adjustment, it is advisable to carry this out with the steering gear held vertically upside down in a suitable fixture after draining off the lubricating oil. When clamped horizontally in a vice, the ball cages may slip out of position before the end cover has been re-secured.

When it is necessary to remove the drop arm from the taper splined end of the rockershaft, a proper extracting tool must be employed. Hammering is likely to damage the gear and often leads to no further progress in any event due to the firm hold of the arm on the taper.

After the vehicle has been initially run-in and oil changes are made to engine and gearbox, etc., the high spot on the cam may have been lost due to "bedding down" of the new parts. Therefore it is recommended that at this stage the appropriate thrust screw adjustment should be made (in the manner already described) to ensure that the centre is correct. It should then remain in adjustment for some time.

### FRONT SUSPENSION

The front wheels are suspended independently, and slide vertically on the main axle pins which hold the complete assemblies in position.

The sliding axles, wheel spindles, and brake plates form complete units and require no other attention than that of lubrication as directed.

The Morgan Plus Four is fitted with simple steering dampers, consisting of a flat spring steel arm, free to slide at one end, and fitted at the other end with a phosphor bronze ring which is assembled between the main coil spring and the top face of the stub axle body.

The purpose of this damper is to prevent any twisting motion set up in the springs when under compression, being transmitted to the stub axles and interfering with the steering.

Phosphor bronze bushes are pressed into the sliding axles and should last a long time unless lubrication is neglected. New bushes become necessary with wear, but a period at which renewals should be made cannot be laid down, as this is primarily dependent on the attention or otherwise which the owner may give to maintenance and lubrication.

When new bushes are required, it is recommended that the sliding axle assemblies be sent to the works for them to be fitted. The method of dismantling is simple, and is carried out as follows :—

Jack up the front of the car to a height of at least 15 inches, and remove the road wheels. It is advisable to put suitable blocks under the front of the car, in order that it will remain firm while this work is being carried out. Remove the pins from the track rod ends, drain the braking system and uncouple the flexible brake pipes, remove the nuts over the top axle tube and lugs. Next, remove the nut from the bottom axle end lug plate. Precaution should be taken when finally removing these two bolts, to see that the rebound spring does not fly out.

When re-assembling, see that all nuts are properly tightened. Check the front wheels for correct alignment, and bleed the hydraulic braking system.

## BRAKES

Girling Hydraulic brakes are fitted to all four wheels. Two leading shoe type being used on front wheels, leading and trailing shoe type on rear wheels.

The pedal operates the brakes on all four wheels hydraulically whilst the handbrake control operates the brakes on the rear wheels, by means of cable and rods.

It must be remembered that the presence of oil, grease or similar foreign matter on a brake shoe will seriously affect the coefficient of friction and in consequence the retarding effect of that particular brake, in spite of the fact that it is being applied with the same force as the others. In such cases, the brake drum should be thoroughly cleaned with petrol and the brake shoes replaced by new shoes and linings. Cleaning the linings is not satisfactory.

See page 18 for checking level of fluid in reservoir. If it is found to be particularly low it is an indication that a leak has developed somewhere in the system and it should be traced and rectified without delay.

Do not reline the shoes, but fit genuine Girling replacement shoes. These shoes have the right type of lining machined to the correct radii.

Should the shoes be removed, care must be exercised to ensure that the pull-off springs are located behind the shoes and hooked through the correct holes.

### ADJUSTMENT OF BRAKE SHOES

After a considerable mileage it may be found necessary to adjust the brakes. This is evident when the brake pedal has to be depressed to within 1" of the floor before the brakes operate. There are TWO adjusters to each front wheel and ONE to each rear wheel.

The procedure necessary to correctly adjust the brakes is :

1. Apply the brakes hard with the car stationary, to position the shoes in the drum, then release brake.
2. Jack up the car, and it is recommended to remove the wheels, although this is not essential.
3. To adjust the front brakes turn with a spanner the adjuster nuts in a clockwise direction until the brake shoes contact the brake drum, then turn adjuster back until the drum is free. The two adjusting nuts are situated at the front and rear of each backplate.
4. To adjust the rear brake turn the adjuster nut in a clockwise direction until the shoes contact the drum and release back one or

two notches until the drum is free. The single adjuster is placed facing in a forward direction on the backplate.

There is a constant drag on the rear wheels due to the action of the differential and axle oil ; don't confuse this with brake drag.

5. Replace wheels if removed, and let down jack.

### HANDBRAKE ADJUSTMENT

Adjustment of the brake shoes as previously described automatically readjusts the handbrake mechanism. The rods are correctly set before leaving the works and only maladjustment will result from tampering with the mechanism. Cable adjustment may be made by turning the adjuster at the rear of the handbrake cable.

### BLEEDING THE SYSTEM

Except for periodical inspection of the fluid level in the reservoir chamber and lubrication of the handbrake cables and connections (see page 17) no attention should be necessary. If, however, a pipe joint is uncoupled at any time, or the wheel cylinder cups are inspected or replaced, the system must be bled in order to expel any air which may have been admitted.

Air is compressible, and its presence in the system will affect the working of the brakes.

Whilst the majority of owners will prefer to have these operations carried out by their Agent, for the benefit of those desiring to carry out their own running adjustments, the procedure is as follows :—

1. Wipe clean the bleeder nipple of the brake concerned and fit a piece of rubber tube over it, allowing the tube to hang in a clean container partially filled with fluid, so that the end of the pipe is below the level of the fluid.
2. Unscrew the bleeder nipple one complete turn with a suitable spanner. There is only one bleeder nipple to each wheel.
3. The fluid reservoir of the master cylinder must be topped up before commencing the bleeding operation, and must be kept at least half-filled during the whole operation, otherwise more air will be drawn into the system via the master cylinder. Always clean the area around the plug before removing it, this will lessen the risk of grit falling into the chamber after removal of the plug.
4. Depress the brake pedal quickly and allow it to return without assistance. Repeat this pumping operation with a slight pause between each depression of the pedal. Observe the flow of fluid being discharged into the glass jar and when all air bubbles cease to appear, hold the pedal firmly down and securely tighten the bleeder nipple.

Note.—Depending upon the position at which a pipe joint has been uncoupled it will be necessary to bleed the system at either both front or both the back wheels. If the pipe was uncoupled at the master cylinder then the system must be bled at all four wheels.

## JACKING SYSTEM, WHEELS AND TYRES

The Jack is used in the following manner :—

First remove the seat from whichever side of the car it is intended to raise ; lift mat and open metal cover over hole in floor board ; insert jack through hole, mushroom head first ; push pin through hole in chassis cross member and operate by screwing in a clockwise direction. It will be noted that the lug can be adjusted to any desired position according to the position of the car. It is essential that the jack be placed in relation to the angle at which the car is standing, *i.e.*, if on a perfectly flat surface it should be just off upright ; if on a cambered surface it should be so placed that when the car is lifted there is no possibility of sliding eitherway.

### WHEELS

In the normal course of wear and tear, or due to minor impacts, the wheels may develop irregularities, or cease to point directly in the direction of motion. A check should be made periodically to ensure that the wheels are in correct alignment or "track". Every garage possesses an alignment gauge and can carry out a test in a few moments. Errors in alignment can be corrected by adjustment of the track rod, the ends of which are threaded for this purpose. The "Toe-in" for the front wheels should be  $\frac{1}{8}$ "— $\frac{3}{16}$ ". "Toe-out", even in the smallest degree, is to be avoided.

To ensure smooth running especially on the front wheels and at high speeds, it is recommended that wheels and tyres are periodically balanced, this can be carried out by most garages, and the trouble in having this done is well repaid by the results obtained.

### TYRES

The recommended tyre inflation pressures for normal driving are, front and rear 16-18 lbs. per sq. inch, this pressure may be increased when carrying heavy loads, or sustained travelling at high speeds.

Pressures should be checked and adjusted at least once a week. Do this when the tyres are cold and not when they have attained normal running temperatures.

Under-inflation causes rapid and sometimes irregular wear, also the casing may be damaged by excessive bending.

To obtain the best tyre mileage, equal wear and to suppress the development of non even wear on the front tyres, exchange them with the rear tyres at least every 2,000 miles.

## BODY WORK

### HOOD

When erecting the hood, always fix the eyelets in the back panel first and then fix snaps across the top of the windscreen. If secured at the front first some strain will be necessary to pull the eyelets over the eyes, which in time will pull away from the fabric.

However, it is recommended that if the hood is tight when dismantling it is advisable to release it at the rear which avoids straining at the eyelets.

When standing and rain is imminent it may be noted that the loose hood top makes a useful tonneau cover if fitted in the usual way without erecting the hood frame.

### SIDE CURTAINS

It should be remembered that Vybak is easily scratched and soiled, spoiling vision at the sides. When not in use, therefore, do not throw the side curtains carelessly into the rear compartment or they may move about and become damaged.

---

## SERVICE

Our Service depot is especially equipped to take care of customers' requirements, and can at all times undertake anything from adjustments to major repairs and complete overhauls, at reasonable charges consistent with expert workmanship.

Machines or parts sent for repairs must be consigned carriage paid and should be clearly labelled with the sender's name and address.

Instructions should be sent separately stating whether an estimate is required before putting the work in hand. When it is inconvenient to send repairs to the works an accredited "Morgan" Dealer should be consulted. For the convenience of owners a list of these dealers is given on pages 45-46.

## LIST OF "MORGAN" DISTRIBUTORS AND DEALERS

AYLESBURY . . . . .	J. Tofield, Parkfield Garages, Cambridge Street.
BARNSTAPLE . . . . .	Central Garage, Boutport Street.
BEDFORD . . . . .	A. & R. Thomas, Central Garage, Kempston.
BIRMINGHAM . . . . .	Henry Garner Ltd., Alcester Road, Moseley.
BIRMINGHAM . . . . .	Shovelbottoms Ltd., Ladypool Road, B'ham. 12.
BIRMINGHAM . . . . .	H. J. Evans Ltd., 10-12, Bristol Street.
BRADFORD . . . . .	St. Enochs Garage (Bradford) Ltd., Wibsey.
BRISTOL . . . . .	Gould's Garage, 42, Newfoundland Street.
BROMLEY . . . . .	Johnson & Brown, 268-270, High Street.
CAMBRIDGE . . . . .	Hallens Motor Engineers, Union Lane.
CHELMSFORD . . . . .	Hadlers Garage, New Street.
CHESTER . . . . .	Davies Bros., 34, Bridge Street.
CLAY CROSS . . . . .	Kennings Ltd., The Motor People.
COVENTRY . . . . .	The Coventry Motor Mart Ltd., 86, London Road.
CREW . . . . .	W. M. Webster, Mill Street Garage, Mill Street
DERBY . . . . .	Palins Motors, 45/53, Osmaston Road.
GILLINGHAM . . . . .	Burtens, 31/39, Duncan Road.
GRIMSBY . . . . .	J. Sodergren, 29/31, Pasture Street.
HULL . . . . .	Motorsales Ltd., 42/46, Princes Avenue.
HASTINGS . . . . .	Car Mart (Hastings) Co. Ltd., 7, Bank Buildings.
IPSWICH . . . . .	Revetts Ltd., 18, St. Margaret's Green.
KEIGHLEY . . . . .	F. E. Cox (Keighley) Ltd., Bradford Road.
KETTERING . . . . .	Grose (Kettering) Ltd., The Headlands.
KIRKCUDBRIGHT . . . . .	J. J. Aitken & Co. Ltd., Tongland Garage.
LEEDS . . . . .	Peter Bolton Ltd., 14, Harrison Street, Briggate.
LEICESTER . . . . .	Cox's Motors (Leicester) Ltd., 11-15, Codnuit Street.
LINCOLN . . . . .	West (Lincoln) Ltd., 116, High Street.
LONDON, W.1 . . . . .	Basil Roy Ltd., 161, Gt. Portland Street.
LONDON, S.W.9 . . . . .	Pride & Clark Ltd., Stockwell Road.
LONDON . . . . .	Welbeck Motors Ltd., 107, Crawford Street.
LONDON, W.5 . . . . .	F. H. Douglass, 1a, South Ealing Road.
LONDON, N.2 . . . . .	Motourists (London) Ltd., Bishops Court Works, Gt. North Road
LONDON, N.W.6 . . . . .	Raymond Way Motors Ltd., Canterbury Road, Kilburn.
MANCHESTER . . . . .	Ron McKenzie, 961, Chester Road, Stretford.
MALVERN . . . . .	Bowman & Acock Ltd., Pickersleigh Garage, Worcester Road.
MORECAMBE . . . . .	County Garage (Morecambe) Ltd., Lancaster Road.
MONKBRIDGE . . . . .	Haws Garage, Yorks.

NEWTON ABBOT . . . . .	J. E. Green & Co., 87, Queen Street.
NEWCASTLE-ON-TYNE . . . . .	Thos. Hadden Ltd., 101, West Road.
NEWMARKET . . . . .	Golding Garage, Park Lane.
NORWICH . . . . .	Harvey Lane Garages, 34/36, Harvey Lane.
NOTTINGHAM . . . . .	Benetts (Notts.) Ltd., 24/30, Shakespeare Street.
PAIGNTON . . . . .	West End Garages, 145, Totnes Road.
OXFORD . . . . .	Kings Motors (Oxford) Ltd., New Road.
PLYMOUTH . . . . .	Olford's Garage, 87, Crownhill Road, Crownhill.
PRESTON . . . . .	Barton Motors (Preston) Ltd., Corporation Street.
PARKSTONE, Dorset . . . . .	Huxams Ltd., Penn Hill Garage, North Lodge Road.
SHREWSBURY . . . . .	F. Painter & Sons, Service Garage, Ditherington.
SEVEN KINGS . . . . .	Raymond Way Ltd., 773, High Road.
SOUTHAMPTON . . . . .	Alex Bennett, Portswood.
SOUTHPORT . . . . .	Lifes Motors, 32/36, West Street.
SOUTHSEA . . . . .	E. W. Burnett & Sons, Eldon Street.
ST. ALBANS . . . . .	Godfrey & Smith, Holywell Hill.
TAUNTON . . . . .	A. F. Small, Silver Street Motor Works.
TONBRIDGE . . . . .	Tonbridge Motor Service, Speedway House.
WEYMOUTH . . . . .	Pankhurst (Weymouth) Ltd., The Palladium, Town Bridge.
WARMLEY, Glos. . . . .	G.S. Cars (B. V. Gray), Tower Road South.
WESTON-SUPER-MARE . . . . .	Drove Garages, Drove Road.

### CHANNEL ISLANDS

GUERNSEY . . . . .	Motor House Ltd., St. Julians Avenue.
JERSEY . . . . .	Paragon Garages Ltd., 95, Halkett Place.

### EIRE

DUBLIN . . . . .	Gorman Bros., 168, Upper Rathmines.
------------------	-------------------------------------

### NORTHERN IRELAND

BELFAST . . . . .	Victor Ltd., 1/3, Upper Queen Street.
-------------------	---------------------------------------

### SCOTLAND

EDINBURGH . . . . .	Rossleigh Ltd., 43/45, Lothian Road.
GLASGOW, C.4 . . . . .	Scottish Automobile Co., 139, Bothwell Street.

### WALES

HAVERFORDWEST . . . . .	Greens Motors Ltd.
NEWPORT, Mon. . . . .	Royal Oak Garages, Chepstow Road.

### I.O.M.

DOUGLAS . . . . .	J. J. Shimmin, 26, Derby Square.
-------------------	----------------------------------



**" OVERSEAS " MORGAN AGENTS**

AFRICA . . . . .	Robb Motors (Pty.) Ltd., 102 Strand, Capetown. Sandringham Motors Ltd., Durban, Natal. Haaks Garages, 22/24, Sauer Street Ext., Johannesburg.
ARGENTINA . . . . .	Mann George Depots Ltd., Calle San Martin 333, Buenos Aires.
AUSTRALIA . . . . .	Finlay Bros. (Pty.) Ltd., Melbourne. Bryson Industries Ltd., 191-199 William Street, Sydney, N.S.W. W. Richards, 327 Fitzgerald Street, North Perth.
BELGIUM . . . . .	Lucien Riga, Rue Theodore Verhaegen 164, Brussels.
CANADA . . . . .	Windsor Motorcycle Sales, 2,504 Howard Avenue, Windsor, Highway No. 2, Ontario.
FRANCE . . . . .	Jacques Savoye, 237 Boul Pereire, Paris, 17E.
GERMANY . . . . .	Burlington Ltd., 103/5 Ostwall, Krefeld 2.
GIBRALTAR . . . . .	J. Cazes & Co., 143 Main Street.
LEBANON . . . . .	Tamer Freres S.A. P.O.B. 84, Beirut.
MALAYA . . . . .	B.G. Motors, No. 360 Batu Road, Kuala Lumpur.
PORTUGAL . . . . .	Mira Comercial Ltd., Av. Antonio Augusto d'Aguiar 19, 4º E, Lisbon.
MOROCCO . . . . .	Moto-Maroc, Rue Gallieni, Casablanca, Morocco.
SOUTHERN RHODESIA . . . . .	Swift Motors, Salisbury.
SPAIN . . . . .	Autocomercial SL., Apartado 1203, Madrid.
SWEDEN . . . . .	Alpen Gundersen A-B, Stadsskrivaregatan 6. Gothenburg N.
SWITZERLAND . . . . .	R. Wehrlin, Sports Garage, Hauptstrasse 132, Aesch BL.
URUGUAY . . . . .	Shaw & Cia, Cerro Largo 1049, Montevideo.
U.S.A. . . . .	Fergus Imported Cars Inc., 1717 Broadway (at 54th Street), New York 19. Worldwide Automotive Imports Inc., SO. Sepulveda Blyd., Los Angeles 25.
VENEZUELA . . . . .	Distribuidora Imperial, Apartado 2809, Caracas.
NEW ZEALAND . . . . .	Khyber Pass Motors Ltd., 31 High Street, Auckland. Independent Motor Sale Ltd., 138 Wakefield Street, Wellington. T. R. Taylor Ltd., P.O. Box 318, Invercargill.

**WARRANTY**

The goods manufactured by The Morgan Motor Co. Ltd. are supplied with the following express Warranty which excludes all warranties, conditions and liabilities whatsoever implied by Common Law, Statute or otherwise, that is to say :—

In the event of any defect being disclosed in any part or parts of the goods and if the part or parts of the goods alleged to be defective are returned to the Company's works carriage paid within six months from the date when the goods are delivered new to the retail customer, the Company undertakes to examine same and should any fault due to defective materials or workmanship be found on examination by the Company, it will repair the defective part or supply free of charge a new part in place thereof.

This Warranty is limited to the delivery to the purchaser free at the Company's works of part or parts whether new or repaired in exchange for those acknowledged by the Company to be defective.

The Company gives no warranty of the goods except as herein stated, but desires and expects that customers shall make a thorough examination before purchasing.

Persons dealing in the Company's goods are in no way the legal Agents of the Company and have no right or authority to assume any obligations on its behalf expressed or implied or to bind it in any way.

For the purpose of this Warranty the term " Goods " means and includes new cars or vans or chassis or parts thereof including replacement parts manufactured by the Company.

It does not include Tyres, Speedometers, or Electrical Equipment or other proprietary articles or goods not of the Company's own manufacture although supplied by the Company. Proprietary articles are covered by the warranty (if any) given by separate manufacturers. On second hand goods no Warranty is given by the Company or is to be implied.

The Company's responsibility is limited to the terms of this warranty and it shall not be answerable for personal injury, or consequential or resulting liability damage or loss arising from any defects.

The Warranty is dependent upon the strict observance by the purchaser of the following provisions :—

(a) The purchaser shall send to the Company's works such part or parts as are alleged to be defective promptly on discovery of the claimed defect. Transportation is to be prepaid and the said part or parts to be properly packed for transport and clearly marked for identification with the full name and address of the purchaser and with the car and chassis numbers of the vehicle from which the parts were taken.

(b) The purchaser shall post to the Company on or before despatch of such parts as are alleged to be defective a full and complete description of the claim and the reasons therefore.

(c) The decision of the Company on all claims shall be final and the purchaser agrees to accept its decision on all matters relating to defects and the exchange or replacement of parts.

## INDEX

	<i>Page</i>
CHAPTER I	
Controls—Switches—Instruments—Starting and Driving Instruction—Gear Changing—Use of Clutch, etc. . . . .	7
CHAPTER II	
New Engines—Running-in, etc. . . . .	10
CHAPTER III	
Lubrication of :— Chassis — Front Suspension—Engine —Gearbox—Rear Axle . . . . .	12
CHAPTER IV	
Maintenance of :— Engine—Carburettor . . . . .	20
CHAPTER V	
Maintenance of :— Clutch — Gearbox — Transmission Shaft—Rear Axle . . . . .	36
CHAPTER VI	
Maintenance of :—Steering and Front Suspension . . . . .	39
CHAPTER VII	
Maintenance of :— Brakes — Brake Shoe Adjustment Bleeding . . . . .	41
CHAPTER VIII	
Jacking System—Wheels and Tyres—Tyre Pressures . . . . .	43
CHAPTER IX	
Bodywork—Hood and Sidescreens . . . . .	44